

# EV Line Product Catalogue

The smartest charging solution for any situation



# Table of contents

## Smappee EV Line

- Intro
- Product range charging stations
- Charging management and services
- Smappee EV One
- Smappee EV Wall
- Smappee EV Base
- Smappee EV Ultra
- Product overview

# Smappee EV Line: truly intelligent EV charging

## Optimal use of your power thanks to load balancing for AC and DC charging

The Smappee EV Line offers unique smart charging solutions for both homes and businesses and AC and DC charging. Thanks to Smappee's integrated smart energy management technology, EV Line charging stations are equipped with dynamic load balancing and overload protection.

## Up to 6x cheaper by charging with solar or off-peak power.



Smappee offers a simple way to maximise the use of renewable energy throughout the day for each charging session. In this way, you optimise your self-sufficiency and save costs. When solar is not available, Smappee considers off-peak energy or dynamic and capacity rates to charge the cars with the cheapest energy and keep your load peaks under control.

## Scalable and future-proof

Smappee EV Line charging stations are compatible with Smappee Infinity. This way you can optimise your energy consumption and your charging square will be in perfect harmony with your other energy flows. Want more charging stations or more control over time? No problem. Build on your existing installation via the modular Smappee ecosystem. Thanks to the over-the-air updates you will never have to worry about outdated technology.



# A charging solution for every home charging need

|  | Home  |  | Projects only   |   |
|--|---|--|---|---|
|  |  |  |  |  |
|  | <b>EV One</b> <sup>HOME</sup><br>Smart charging                                   | <b>EV Wall</b> <sup>HOME</sup><br>Smart charging                                   | <b>EV One</b> <sup>LITE</sup><br>Simply charging                                    | <b>EV Wall</b> <sup>LITE</sup><br>Simply charging                                   |
| Charge mode  | AC  | AC   | AC  | AC  |
| Max charging capacity                                    | 3 phase, up to 22 kW  | 1 or 3 phase, up to 7.4 or 22 kW   | 3 phase, up to 22 kW  | 3 phase, up to 22 kW  |
| Connectors   | Socket  | Socket or cable 8 m  | Socket  | Socket  |
| Mounting method  | Floor   | Wall-mounted   | Floor   | Wall-mounted  |
| Dimensions   | 1100 x 120 x 120 mm   | 300 x 300 x 110 mm   | 1100 x 120 x 120 mm   | 300 x 300 x 110 mm  |
| Use  | Home  | Home   | Home  | Home  |
| <b>Features &amp; services</b>                           |   |  |   |   |
| Overload protection                                      | Autonomous  | Autonomous   | Fixed max current   | Fixed max current   |
| Building energy management                               | Included  | Included   | No  | No  |
| Solar optimisation                                       | Included  | Included   | No  | No  |
| Charging cost optimisation (off-peak, dynamic, capacity) | Included  | Included   | No  | No  |
| App / Dashboard  | Included  | Included   | Limited   | Limited   |
| Charging data  | Included  | Included   | No  | No  |
| Over-the-air-updates                                     | Included  | Included   | Included  | Included  |
| Upgradable   | Included  | Included   | Yes   | Yes   |
| Connectivity   | Wi-Fi, Ethernet   | Wi-Fi, Ethernet  | Wi-Fi, Ethernet   | Wi-Fi, Ethernet   |
| Session activation                                       | RFID, QR code   | RFID, QR code  | RFID, QR code   | RFID, QR code   |

# A charging solution for every business charging need

## Business



**EV One** BUSINESS  
Compact smart charging at business



**EV Wall** BUSINESS  
Compact smart charging at business



**EV Base**  
Smart charging at business



**EV Ultra**  
Fast DC charging at squares

|   |                             |                             |                             |                             |
|---|-----------------------------|-----------------------------|-----------------------------|-----------------------------|
| <b>Charge mode</b>  | AC                          | AC                          | AC                          | DC fast charging            |
| <b>Max charging capacity</b>                                    | 3 phase, up to 22 kW        | 3 phase, up to 22 kW        | 2 x 3 phase, up to 22 kW    | Up to 80 or 200 kW          |
| <b>Connectors</b>   | Socket                      | Socket or cable 8 m         | 2 sockets or cables 5 m     | Cable 3.25 m                |
| <b>Mounting method</b>  | Floor                       | Wall-mounted                | Floor                       | Floor                       |
| <b>Dimensions</b>   | 1100 x 120 x 120 mm         | 300 x 300 x 110 mm          | 1200 x 600 x 150 mm         | 1860 x 920 x 290 mm         |
| <b>Use</b>  | Charging square             | Charging square             | Charging square             | Charging square             |
| <b>Features &amp; services</b>                                  |                             |                             |                             |                             |
| <b>Overload protection</b>                                      | When combined with Infinity | When combined with Infinity | When combined with Infinity | When combined with Infinity |
| <b>Building energy management</b>                               | When combined with Infinity | When combined with Infinity | When combined with Infinity | When combined with Infinity |
| <b>Solar optimisation</b>                                       | When combined with Infinity | When combined with Infinity | When combined with Infinity | N/A                         |
| <b>Charging cost optimisation (off-peak, dynamic, capacity)</b> | When combined with Infinity | When combined with Infinity | When combined with Infinity | N/A                         |
| <b>App / Dashboard</b>  | Included                    | Included                    | Included                    | Included                    |
| <b>Charging data</b>  | Included                    | Included                    | Included                    | Included                    |
| <b>Over-the-air-updates</b>                                     | Included                    | Included                    | Included                    | Included                    |
| <b>Upgradable</b>   | Included                    | Included                    | Included                    | Included                    |
| <b>Connectivity</b>   | Ethernet                    | Ethernet                    | Ethernet                    | Ethernet, 4G                |
| <b>Session activation</b>                                       | RFID, QR code               | RFID, QR code               | RFID, QR code               | RFID, QR code               |

# Powerful EV charging management platform

When you buy a Smappee smart charging solution, you also get immediate access to our complete charging management platform. It takes care of all aspects related to electric charging. The Smappee Dashboard offers numerous features that help manage and operate your charging stations or charging square.

## Manage each charging point remotely

As soon as you place multiple charging points on your premises where different users come to charge, you need more control. The Smappee smart charging platform offers that control... and more. Use the Smappee Dashboard to add priority charging, set tariffs, close your charging stations outside office hours, etc. In addition, you can track the status of all your charging points in real-time and quickly solve problems remotely.

## Priorities and whitelisting

Easily manage charging revenues by applying different charging rates and priorities down to user level. Via the Smappee Dashboard you can allocate priorities to the Smappee Smart Charge Cards. That way, your sales team or visitor is on the road again fully charged in no time. Or whitelist the Smappee RFID cards for your employees and visitors to charge for free or at a reduced rate on your charging square.

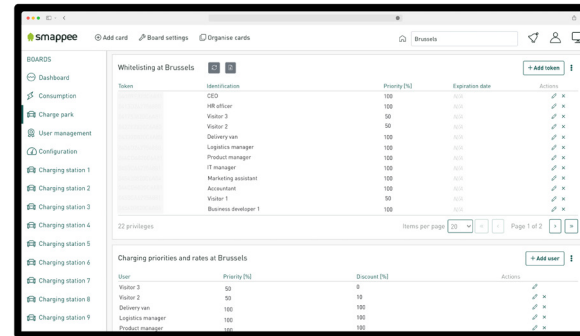
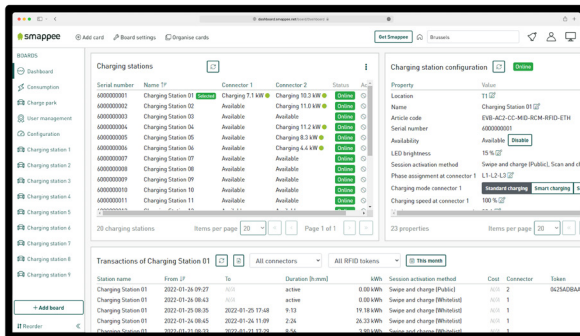

## Charging costs and split billing

Get an extensive overview of charging sessions, costs, and revenues per charging point via the Smappee Dashboard. Manage every charging point, on premise or remotely at your employee's house, and easily offer split billing based on the data in the dashboard. That way, you can reimburse your employees for the charges at home or bill them correctly for the charging sessions at your charging square.

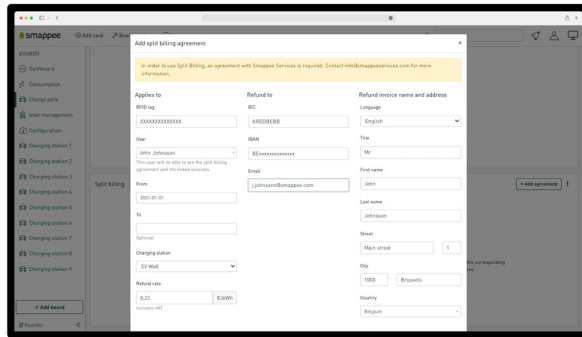

## Smappee CPO services

Choose Smappee for a simple and easy all-in-one payment solution. The Smappee CPO services take care of the payment and invoicing of the charges at your charging stations. EV drivers can charge using their charge cards. Smappee will then reimburse you for the charges periodically.

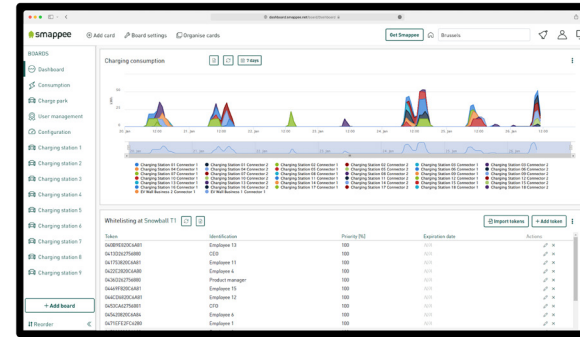

# Smappee EV One LITE / PROJECTS ONLY

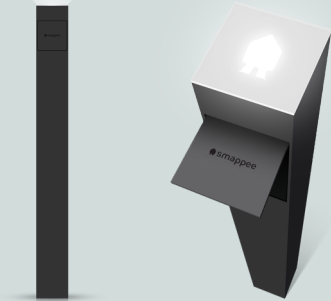

- Manually set up overload protection with fixed maximum current.
- Control charging sessions with QR code, RFID.
- Easy and simple to install.
- Secure OCPP and OCPP roaming.

The Smappee EV One Lite is a floor-mounted EV charging station with socket for standalone use at home. It provides overload protection by manually setting a fixed maximum current. The EV One Lite is easy to install with simple cable configuration and installation wizard. The integrated LED lighting indicates charging status. Charging sessions can be started and stopped via QR code and RFID.

#### Dimensions:

1100 × 120 × 120 mm

#### Weight:

9,3 kg

#### Operating temperature:

-25 °C to 40 °C

#### Storage temperature:

-25 °C to 60 °C

#### Relative humidity:

0 % - 95 %, non-condensing

#### Operating altitude:

0 - 2,000 m

#### Standards:

IEC 61851-1

#### Product certifications:

CE

#### Connectivity:

- Wi-Fi 2.4 GHz
- Ethernet 100BASE-T

#### Communication protocol:

OCPP 1.6 J, ready for update to OCPP 2.0.1

#### Mounting method:

Floor

#### Enclosure:

- Material: Magnelis (structure), aluminium (housing)
- Rating: IP54 / IK10
- Standard colour: RAL7021 (black grey)

#### Integrated Residual Current Protection:

Rated operating residual current detection: 6 mA DC

#### Charging:

- Maximum charging capacity: 22 kW
- Output power: 3 phase, 230 V – 400 V, 32 A
- Charge mode: Mode 3 (IEC 61851)
- Charging activation: QR code / Plug and charge / RFID
- Information status: RGB LED
- kWh meter compliant with IEC 62053-21

#### Connectors:

1 × type 2 socket



## EV One Lite - What's in the box?



EV One Lite



Quick Starter  
Guide



Quick Install  
Guide



Smart Charge Card



QR code sticker

# Smappee EV One <sup>HOME</sup>

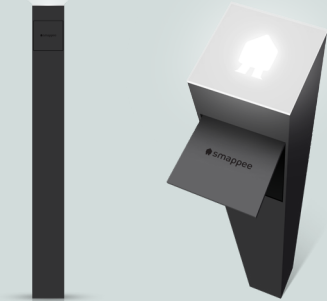

- Integrated local autonomous overload protection and solar optimisation.
- Insights and control over charging process and costs.
- Real-time and historical energy data - grid, solar, always-on.
- Control charging sessions with QR code, RFID and smart schedules.
- Easily expandable with Smappee Infinity for more home energy management.
- Secure OCPP and OCPP roaming.

The Smappee EV One Home is a floor-mounted smart EV charging station with one connector, for standalone use at home. Thanks to the integrated Smappee Infinity technology it ensures autonomous overload protection and optimised self-consumption. Receive detailed insights on your energy usage and production, the charging process and costs via the App and Dashboard. The EV One Home is easy to install with simple cable configuration and installation wizard. The integrated LED lighting indicates charging status. Charging sessions can be started and stopped via QR code, RFID and smart EV schedules.

#### Dimensions:

1100 × 120 × 120 mm

#### Weight:

9,5 kg

#### Operating temperature:

-25 °C to 40 °C

#### Storage temperature:

-25 °C to 60 °C

#### Relative humidity:

0 % - 95 %, non-condensing

#### Operating altitude:

0 - 2,000 m

#### Standards:

IEC 61851-1

#### Product certifications:

CE

#### Connectivity:

- Wi-Fi 2.4 GHz

- Ethernet 100BASE-T

#### Communication protocol:

OCPP 1.6 J, ready for update to OCPP 2.0.1

#### Mounting method:

Floor

#### Enclosure:

- Material: Magnelis (structure), aluminium (housing)
- Rating: IP54 / IK10
- Standard colour: RAL7021 (black grey)

#### Integrated Residual Current Protection:

Rated operating residual current detection: 6 mA DC

#### Integrated Energy Management:

Grid & solar measurements

#### Charging:

- Maximum charging capacity: 22 kW
- Output power: 3 phase, 230 V – 400 V, 32 A
- Charge mode: Mode 3 (IEC 61851)
- Charging activation: QR code / Plug and charge / RFID
- Information status: RGB LED
- kWh meter compliant with IEC 62053-21

#### Connectors:

1 × type 2 socket

## EV One Home - What's in the box?



EV One Home



EV Wall splitter



DIN mounting plate



Connect



Wall mounting plate



Quick Starter Guide



Quick Install Guide



CT Hub



CT 50A



RJ10 cable 40 cm



RJ10 cable 150 cm



QR code sticker



Smart Charge Card



Bus termination plug

In case of three phase connection set-up, additional components:



CT 50A



Solid Core 3-phase CT

# Smappee EV One BUSINESS

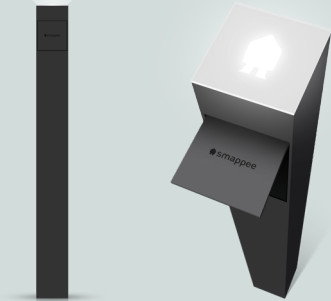

- Solar optimisation and autonomous overload protection.
- Real-time and historical charging costs.
- Control charging sessions with QR code, RFID or smart schedules.
- Integrated MID-meter for MID-graded invoicing.
- Works stand-alone or combined with Smappee Infinity for smart features.
- Secure OCPP and OCPP roaming.

The Smappee EV One Business is a floor-mounted smart EV charging station with one connector, designed for use in a business environment. When combined with Smappee Infinity it ensures autonomous overload protection and optimised selfconsumption. Detailed insights on your charging process and costs can be received via the App and Dashboard. The EV One Business is easy to install with simple cable configuration and an installation wizard. The integrated LED lighting indicates charging status. Multiple payment options are available via QR code or RFID.

**Dimensions:**

1100 × 120 × 120 mm

**Weight:**

9,4 kg

**Operating temperature:**

-25 °C to 40 °C

**Storage temperature:**

-25 °C to 60 °C

**Relative humidity:**

0 % - 95 %, non-condensing

**Operating altitude:**

0 - 2,000 m

**Standards:**

IEC 61851-1

**Product certifications:**

CE

**Connectivity:**

Ethernet 100BASE-T

**Communication protocol:**

OCPP 1.6 J, ready for update to OCPP 2.0.1

**Mounting method:**

Floor

**Enclosure:**

- Material: Magnelis (structure), aluminium (housing)
- Rating: IP54 / IK10
- Standard colour: RAL7021 (black grey)

**Integrated Residual Current Protection:**

Rated operating residual current detection: 6 mA DC

**Charging:**

- Maximum charging capacity: 22 kW
- Output power: 3 phase, 230 V – 400 V, 32 A
- Charge mode: Mode 3 (IEC 61851)
- Charging activation: QR code / Plug and charge / RFID
- Information status: RGB LED
- MID metering, certified class B

**Connectors:**

- 1 × type 2 socket

## EV One Business - What's in the box?



EV One Business



Quick Starter Guide



Quick Install Guide



Smart Charge Card



QR code sticker

# Smappee EV Wall LITE / PROJECTS ONLY

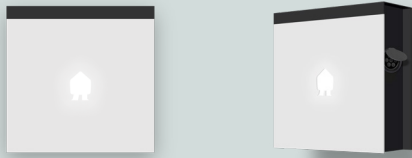

- Real-time and historical charging costs.
- Manually set up overload protection with fixed maximum current.
- Control charging sessions with QR code, RFID.
- Easy and simple to install.
- Secure OCPP and OCPP roaming.

The Smappee EV Wall Lite is a wall-mounted EV charging station with socket for standalone use at home. It provides overload protection by manually setting a fixed maximum current. The EV Wall Lite is easy to install with simple cable configuration and installation wizard. The integrated LED lighting indicates charging status. Charging sessions can be started and stopped via QR code, RFID. Receive detailed insights on your charging process and costs via the Smappee App.

**Dimensions:**

300 × 300 × 110 mm (station)

**Weight:**

6.2 kg

**Operating temperature:**

-25 °C to 40 °C

**Storage temperature:**

-25 °C to 60 °C

**Relative humidity:**

0 % - 95 %, non-condensing

**Operating altitude:**

0 - 2,000 m

**Standards:**

IEC 61851-1

**Product certifications:**

CE

**Connectivity:**

- Wi-Fi 2.4 GHz

- Ethernet 100BASE-T

**Communication protocol:**

OCPP 1.6 J, ready for update to OCPP 2.0.1

**Mounting method:**

Wall

**Enclosure:**

- Material: Magnelis (structure), aluminium (front plate)

- Rating: IP54 / IK10

- Standard colours: RAL9016 (star white) + RAL7021 (black grey)

**Integrated Residual Current Protection:**

Rated operating residual current detection: 6 mA DC

**Charging:**

- Maximum charging capacity: 22 kW

- Output power: 3 phase, 230 V – 400 V, 32 A

- Charge mode: Mode 3 (IEC 61851)

- Charging activation: QR code / Plug and charge / RFID

- Information status: RGB LED

- kWh meter compliant with IEC 62053-21

**Connectors:**

- 1 × type 2 socket (right) – optional shutter

## EV Wall Lite - What's in the box?

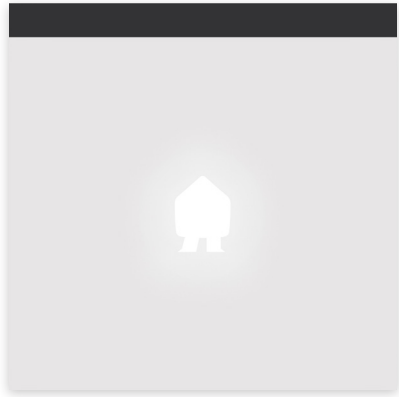

EV Wall Lite

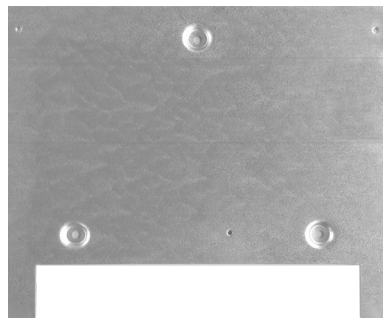

EV Wall mounting plate



Quick Starter Guide



Quick Install Guide



Smart Charge Card



Screw & plug



Small screw



QR code sticker

# Smappee EV Wall HOME



- Integrated local autonomous overload protection and solar optimisation.
- Insights and control over charging process and costs.
- Real-time and historical energy data - grid, solar, always-on.
- Control charging sessions with QR code, RFID and smart schedules.
- Easily expandable with Smappee Infinity for more home energy management.
- Secure OCPP and OCPP roaming.

The Smappee EV Wall Home is, a wall-mounted smart EV charging station with one connector, for standalone use at home. Thanks to the integrated Smappee Infinity technology it ensures autonomous overload protection and optimised self-consumption. Receive detailed insights on your energy usage and production, the charging process and costs via the App and Dashboard. The EV Wall Home is easy to install with simple cable configuration and installation wizard. The integrated LED lighting indicates charging status. It comes with a fixed cable or socket. Charging sessions can be started and stopped via QR code, RFID and smart EV schedules.

## Dimensions:

- 300 × 300 × 110 mm (station)
- Socket or charging cable 8 m with cable holder

## Weight:

- EV Wall station: 5.3 kg
- EV Wall incl. 1 fixed cable (8 m): 9.8 kg
- EV Wall incl. 1 socket: 6.2 kg

## Operating temperature:

-25 °C to 40 °C

## Storage temperature:

-25 °C to 60 °C

## Relative humidity:

0 % - 95 %, non-condensing

## Operating altitude:

0 - 2,000 m

## Standards:

IEC 61851-1

## Product certifications:

CE

## Connectivity:

- Wi-Fi 2.4 GHz
- Ethernet 100BASE-T

## Communication protocol:

OCPP 1.6 J, ready for update to OCPP 2.0.1

## Mounting method:

Wall

## Enclosure:

- Material: Magnelis (structure), aluminium (front plate)
- Rating: IP54 / IK10
- Standard colours: RAL9016 (star white) + RAL7021 (black grey)

## Integrated Residual Current Protection:

Rated operating residual current detection: 6 mA DC / 30 mA RCD Type A

## Integrated Energy Management:

Grid & solar measurements

## Charging:

- Maximum charging capacity: 7.4 to 22 kW
- Output power: Single or 3 phase, 230 V – 400 V, 32 A
- Charge mode: Mode 3 (IEC 61851)
- Charging activation: QR code / Plug and charge / RFID
- Information status: RGB LED
- kWh meter compliant with IEC 62053-21

## Connectors:

- 1 × fixed cable with type 2 connector (right)
- 1 × type 2 socket (right) - optional shutter



## EV Wall Home - What's in the box?

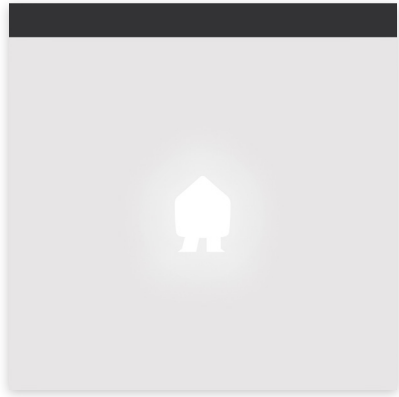

EV Wall Home

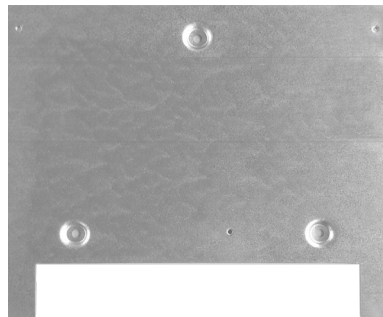

EV Wall mounting plate



EV Wall splitter



CT Hub



Bus termination plug

In case of cable version, additional components:



8m charging cable



DIN mounting plate



CT 50A



Screw & plug



Cable holder



Connect



RJ10 cable 40 cm



Small screw



Cable gland



Wall mounting plate



RJ10 cable 150 cm



Cable tie



Quick Starter Guide



QR code sticker



Quick Install Guide



Smart Charge Card

In case of three phase connection set-up, additional components:



CT 50A



Solid Core 3-phase CT

## EV Wall Home single phase connection diagram

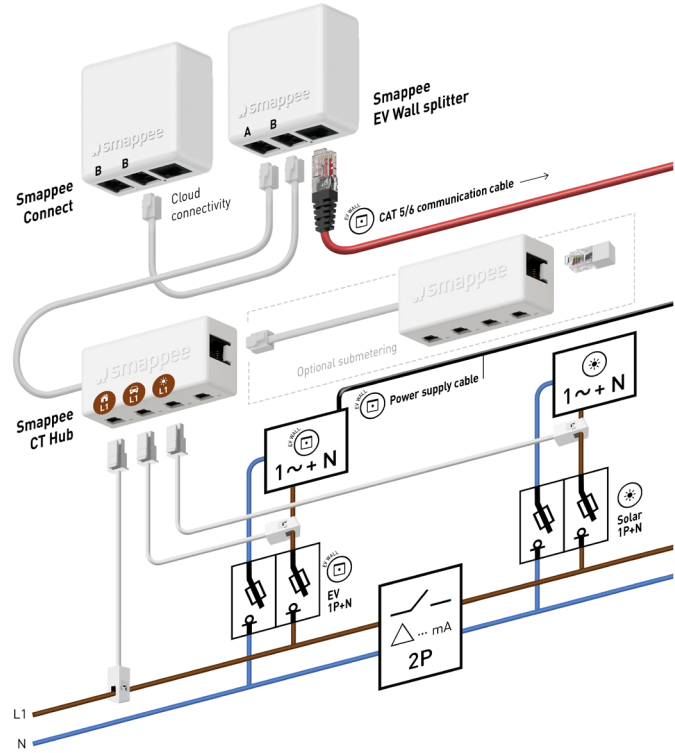

## EV Wall Home three phase connection diagram

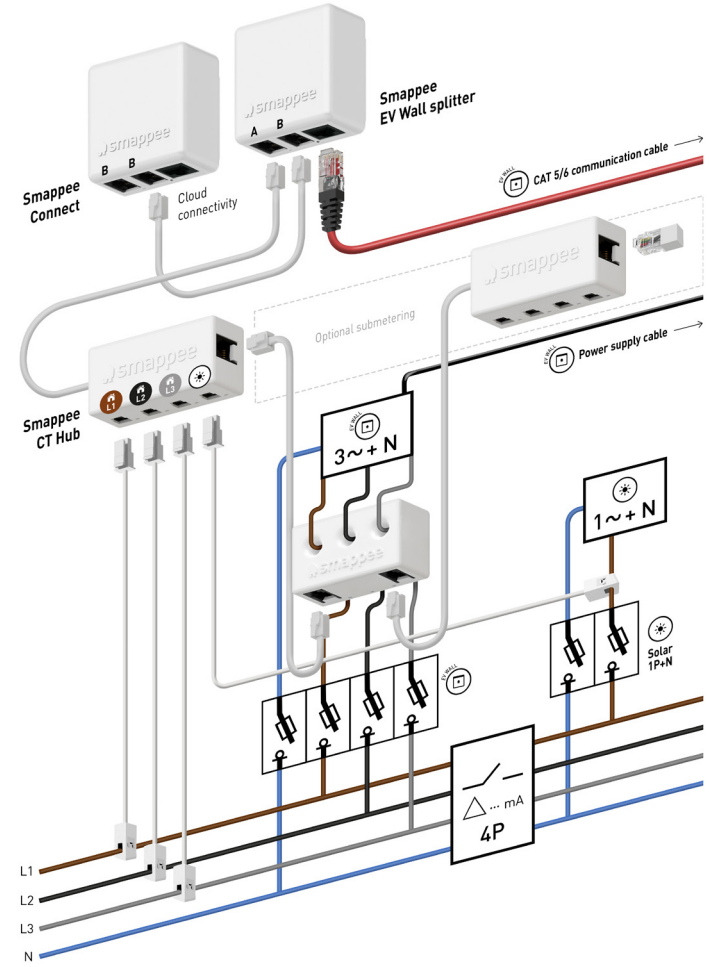

# Smappee EV Wall BUSINESS



- Solar optimisation and autonomous overload protection.
- Real-time and historical charging costs.
- Control charging sessions with QR code, RFID or smart schedules.
- Integrated MID-meter for MID-graded invoicing.
- Works stand-alone or combined with Smappee Infinity for smart features.
- Secure OCPP and OCPP roaming.

The Smappee EV Wall Business is a wall-mounted smart EV charging station with one connector, to use in a multiple setup in a business environment. When combined with Smappee Infinity it ensures autonomous overload protection and optimised selfconsumption. Receive detailed insights on your charging process and costs via the App and Dashboard. The EV Wall Business is easy to install with simple cable configuration and installation wizard. The integrated LED lighting indicates charging status. It comes with a fixed cable or socket and offers multiple payment options via QR code or RFID.

#### Dimensions:

- 300 × 300 × 110 mm (station)
- Socket or charging cable 8 m with cable holder

#### Weight:

- EV Wall station: 5.3 kg
- EV Wall incl. 1 fixed cable (8 m): 9.8 kg
- EV Wall incl. 1 socket: 6.2 kg

#### Operating temperature:

-25 °C to 40 °C

#### Storage temperature:

-25 °C to 60 °C

#### Relative humidity:

0 % - 95 %, non-condensing

#### Operating altitude:

0 - 2,000 m

#### Standards:

IEC 61851-1

#### Product certifications:

CE

#### Connectivity:

- Ethernet 100BASE-T

#### Communication protocol:

OCPP 1.6 J, ready for update to OCPP 2.0.1

#### Mounting method:

Wall

#### Enclosure:

- Material: Magnelis (structure), aluminium (front plate)
- Rating: IP54 / IK10
- Standard colours: RAL9016 (star white) + RAL7021 (black grey)

#### Integrated Residual Current Protection:

Rated operating residual current detection: 6 mA DC / 30 mA RCD Type A

#### Charging:

- Maximum charging capacity: 7.4 to 22 kW
- Output power: 3 phase, 230 V – 400 V, 32 A
- Charge mode: Mode 3 (IEC 61851)
- Charging activation: QR code / Plug and charge / RFID
- Information status: RGB LED
- MID metering, certified class B

#### Connectors:

- 1 × fixed cable with type 2 connector (right)
- 1 × type 2 socket (right) - optional shutter

## EV Wall Business - What's in the box?

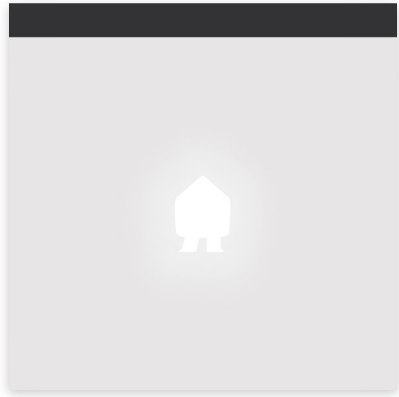

EV Wall Business



Quick Starter Guide



Quick Install Guide



Smart Charge Card



Screw & plug



Small screw



QR code sticker

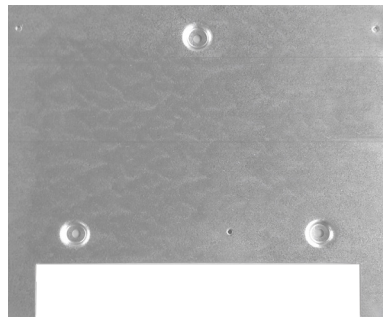

EV Wall mounting plate

In case of cable version,  
additional components:



8m charging cable



Cable holder



Cable gland



Cable tie

# Smappee EV Base



- Solar optimisation and autonomous overload protection.
- Real-time and historical charging costs.
- Priority charging, multiple rates and easy payment options with QR code or RFID.
- Works stand-alone or combined with Smappee Infinity for smart features.

The Smappee EV Base is a floor-mounted smart EV charging station with two connectors. When combined with Smappee Infinity, it offers smart charging, ensuring optimised self-consumption and autonomous overload protection. Users and operators receive detailed insights in the charging process and costs via the App and Dashboard. The EV Base is easy to install with simple cable configuration and installation wizard. The integrated LED lighting indicates charging status and ensures sufficient visibility in the parking area. It comes with fixed cables or sockets and offers multiple payment options via QR codes or RFID.

#### Dimensions:

- 1200 × 600 × 150 mm (station)
- Charging cable 5 m

#### Weight:

- EV Base station: 34 kg
- Cable 5 m: 3 kg

#### Operating temperature:

-25 °C to 40 °C

#### Storage temperature:

-25 °C to 60 °C

#### Relative humidity:

0 % - 95 %, non-condensing

#### Operating altitude:

0 - 2,000 m

#### Standards:

IEC 61851-1

#### Product certifications:

CE

#### Connectivity:

- Ethernet 100BASE-T

#### Communication protocol:

OCPP 1.6 J, ready for update to OCPP 2.0.1

#### Mounting method:

Floor

#### Enclosure:

- Material: Magnelis (structure), aluminium (back plate)
- Rating: IP54 / IK10
- Standard: RAL9016 (star white) + RAL7021 (black grey)

#### Integrated Residual Current Protection:

Rated operating residual current detection:  
6 mA DC / 30 mA RCD Type A

#### Charging:

- Maximum charging capacity:  
22 kW per connector
- Output power: 230 V – 400 V, 32 A
- Charge mode: Mode 3 (IEC 61851)
- Charging activation: QR code / Plug and charge / RFID
- Information status: RGB LED
- MID metering, certified class B

#### Connectors:

- 2 × fixed cable with type 2 connector
- 2 x type 2 socket - optional shutter

## EV Base - What's in the box?

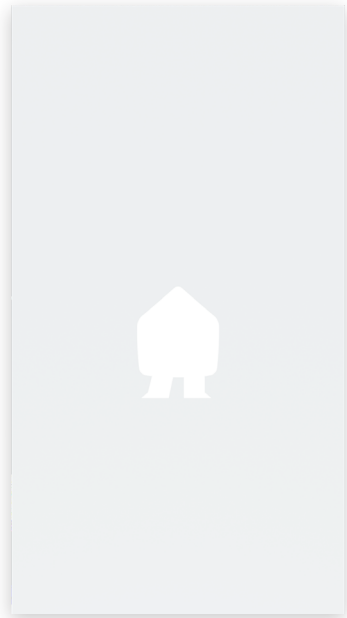

EV Base unit



Floor plate



x2

QR code sticker



Quick Install Guide



x4

Concrete anchors



x4

Washers



x4

Screws



x4

Washers

In case of fixed cable version:



x2

Open-ended 5m charging cable



x2

Cable gland



x2

Cable tie

# Smappee EV Ultra

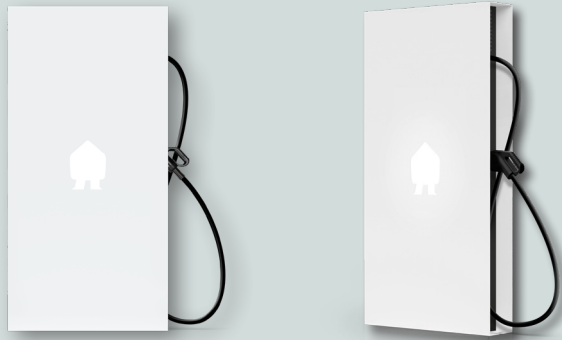

- Fast DC charging for CCS2 vehicles.
- Dynamic and cluster load balancing of Smappee EV Line.
- Priority charging, multiple rates and easy payment options with QR code or RFID.
- Elegant design with LED lighting for increased visibility and security.
- Easy smart charging management with one single platform.

The Smappee EV Ultra is a floor-mounted fast charger with one CCS2 connector to use in a multiple setup in a business environment. When combined with Smappee Infinity it ensures autonomous overload protection. Smappee's smart charging platform offers users and operators detailed data on the charging process and costs and allows for remote control over multiple charging points. Payments are made via QR code or RFID token. The integrated LED indicates charging status and offers visibility and safety in the parking area. Its robust all-weather enclosure, high-quality materials, modular set-up, and over-the-air updates make the EV Ultra durable and future-proof.

## Dimensions:

- 1860 × 920 × 290 mm (station)
- Charging cable 3.25 m

## Weight:

- EV Ultra station:  
250 kg (200S) - 200 kg (80S)
- Cable 3.25 m: 9 kg

## Operating temperature:

- 25 °C to 40 °C (50 °C with derating)

## Storage temperature:

- 25 °C to 60 °C

## Relative humidity:

- 0 % - 95 %, non-condensing

## Operating altitude:

- 0 - 2,000 m

## Standards:

- IEC 61851-21, ISO 15118

## Product certifications:

- CE

## Connectivity:

- Ethernet 100BASE-T
- LTE CAT M1 (4G)

## Communication protocol:

- OCPP 1.6 J, ready for update to OCPP 2.0.1

## Mounting method:

- Floor

## Enclosure:

- Material: Magnelis
- Standard colours: RAL9016 (star white) + RAL7021 (black grey)
- Rating: IP 54 / IK 10
- Acoustic noise: 0 dB - 60 dB
- Indoor / outdoor use

## Nominal input:

- Power supply: 3P
- Rated voltage (Un): 400 Vac ± 10 %
- Rated frequency (fn): 50 Hz
- Nominal input current:  
300 A (200S) - 125 A (80S)
- Power factor: > 0.98 at full capacity
- Efficiency: 95 % at full capacity
- Connection method: AC, permanently connected

## DC Output:

- Charge mode: Mode 4 (IEC 61851)
- DC Plug: CCS2
- Connection case: Case C (fixed cable)
- Maximum current: 400 A (200S) - 200 A (80S)
- Nominal power: 200 kW (200S) - 80 kW (80S) at 400 V - 1,000 V

## Interfaces:

- Information status: RGB LED
- Session activation: QR code / RFID

## EV business basic set-up



### Infinity

Dynamic load balancing  
Solar optimisation  
Autonomous overload protection



Cloud

Internet connectivity via ethernet (preferred), Wi-Fi or 4G



EV One Business



EV Wall Business



EV Base



EV Ultra



### App and Dashboard

For control over charging stations and energy use.



# Smappee EV Line product overview.

## EV One <sup>LITE</sup>

|                | EAN           | Description               | Sales Price                             |
|----------------|---------------|---------------------------|---|
| EVOL-332-B-E-B | 5425036934047 | EV One Lite 3-Phase 22 kW | Contact your Smappee Business Developer |

## EV One <sup>HOME</sup>

|               | EAN           | Description               | Sales Price                             |
|---------------|---------------|---------------------------|---|
| EVO-332-B-E-B | 5425036934054 | EV One Home 3-Phase 22 kW | Contact your Smappee Business Developer |

## EV One <sup>EICHRECHT</sup>

|                | EAN           | Description                    | Sales Price                             |
|----------------|---------------|--------------------------------|---|
| EVOE-332-B-E-B | 5425036934078 | EV One Eichrecht 3-Phase 22 kW | Contact your Smappee Business Developer |

## EV One <sup>BUSINESS</sup>

|                | EAN           | Description                   | Sales Price                             |
|----------------|---------------|-------------------------------|---|
| EVOB-332-B-E-B | 5425036934061 | EV One Business 3-Phase 22 kW | Contact your Smappee Business Developer |

# Smappee EV Line product overview.

## EV Wall <sup>LITE</sup>

|                  | EAN           | Description  | Sales Price                             |
|------------------|---------------|--|---|
| EVWL-332-BR-E-W  | 5425036933989 | EV Wall Lite White 3-Phase 22 kW Socket              | Contact your Smappee Business Developer |
| EVWL-332-BSR-E-W | 5425036933996 | EV Wall Lite White 3-Phase 22 kW Socket with shutter |   |

## EV Wall <sup>HOME</sup>

|                 | EAN           | Description  | Sales Price                             |
|-----------------|---------------|--|---|
| EVW-132-BR-E-W  | 5425036931916 | EV Wall Home White 1-Phase 7.4 kW Socket                             | Contact your Smappee Business Developer |
| EVW-132-BSR-E-W | 5425036932722 | EV Wall Home White 1-Phase 7.4 kW Socket with shutter                |   |
| EVW-132-C8R-E-W | 5425036931992 | EV Wall Home White 1-Phase 7.4 kW Type 2 cable 8 m with cable holder |   |
| EVW-332-BR-E-W  | 5425036932036 | EV Wall Home White 3-Phase 22 kW Socket                              |   |
| EVW-332-BSR-E-W | 5425036932739 | EV Wall Home White 3-Phase 22 kW Socket with shutter                 |   |
| EVW-332-C8R-E-W | 5425036932111 | EV Wall Home White 3-Phase 22 kW Type 2 cable 8 m with cable holder  |   |

## EV Wall <sup>BUSINESS</sup>

|                  | EAN           | Description   | Sales Price                             |
|------------------|---------------|---|---|
| EVWB-332-BR-E-W  | 5425036932159 | EV Wall Business White 3-Phase 22 kW Socket                             | Contact your Smappee Business Developer |
| EVWB-332-BSR-E-W | 5425036932746 | EV Wall Business White 3-Phase 22 kW Socket with shutter                |   |
| EVWB-332-C8R-E-W | 5425036932234 | EV Wall Business White 3-Phase 22 kW Type 2 cable 8 m with cable holder |   |

## EV Base

|               | EAN           | Description                                   | Sales Price                             |
|---------------|---------------|---|---|
| EVB-2332-B-E  | 5425036932272 | EV Base 3-Phase 2 x 22 kW Socket              | Contact your Smappee Business Developer |
| EVB-2332-BS-E | 5425036932753 | EV Base 3-Phase 2 x 22 kW Socket with shutter |   |
| EVB-2332-C5-E | 5425036932296 | EV Base 3-Phase 2 x 22 kW Type 2 cable 5 m    |   |

## EV Ultra

|                | EAN           | Description   | Sales Price                             |
|----------------|---------------|---------------|---|
| EVBU-80-CCS3R  | 5425036933873 | EV Ultra 80S  | Contact your Smappee Business Developer |
| EVBU-200-CCS3R | 5425036933767 | EV Ultra 200S |   |

## Accessories

|                  | EAN           | Description   | Sales Price                             |
|------------------|---------------|---|---|
| EVW-SOLAR        | 5425036932364 | Solar add-on (1 x Smappee CT Hub + 2 x 50 A Current Transformers) | Contact your Smappee Business Developer |
| EV-100A-KIT      | 5425036934009 | EV Line 100 A Kit   |   |
| EV-RFID-CARDS-10 | 5425036931879 | RFID package of 10 Smappee RFID cards                             |   |
| EV-CBL-HOLDER    | 542503693346  | EV Line cable holder  |   |
| EVW-COVER-W      | 542503693353  | EV Wall White front plate   |   |

## Extended warranty

|                 | EAN           | Description                                      | Sales Price                                   |
|-----------------|---------------|--|---|
| EVW-WARRANTY-5  | 5425036932593 | Warranty package EV Wall (extension to 5 years)  | Contact your<br>Smappee Business<br>Developer |
| EVO-WARRANTY-5  | 5425036934016 | Warranty package EV One (extension to 5 years)   |   |
| EVB-WARRANTY-5  | 5425036934023 | Warranty package EV Base (extension to 5 years)  |   |
| EVBU-WARRANTY-5 | 5425036934030 | Warranty package EV Ultra (extension to 5 years) |   |

## Charging Packages

### Charge Point Operator Smappee - Make your EV Charger available for third parties

- Smappee CPO services, allowing 3<sup>rd</sup> party RFID cards
- Invoiced/credited monthly

Offered by Smappee Services more info how to enable on Smappee Help Center.

### Split billing - Reimburse your employees for the charges at home

- Smappee Split billing - charge with assigned RFID Card
- Invoiced/credited monthly

Offered by Smappee Services more info how to enable on Smappee Help Center.

Contact your Smappee Business Developer for pricing

## EV Line dummy charging stations

|               | EAN           | Description                           | Sales Price                                   |
|---------------|---------------|---------------------------------------|---|
| DUMMY-EVB-2B  | 5425036933675 | Dummy EV Base 2 x Socket              | Contact your<br>Smappee Business<br>Developer |
| DUMMY-EVB-2BS | 5425036933682 | Dummy EV Base 2 x Socket with shutter |   |
| DUMMY-EVB-2C5 | 5425036933682 | Dummy EV Base 2 x Type 2 cable 5m     |   |
| DUMMY-EVW-BR  | 5425036933156 | Dummy EV Wall Socket                  |   |
| DUMMY-EVW-BSR | 5425036933224 | Dummy EV Wall Socket with shutter     |   |
| DUMMY-EVW-C8R | 5425036933224 | Dummy EV Wall Type 2 cable 8m         |   |
| DUMMY-EVO     | 5425036934085 | Dummy EV One                          |   |

Dummy charging stations have a working LED, but cannot charge an electric car.

## General terms and conditions

[www.smappee.com/conditions](http://www.smappee.com/conditions)